

# Industrial Casters & Wheels



**Flexell** 

Available in North America from:





## Joining Forces to Offer You More Choice

Revvo announces the teaming up of the Revvo and Flexello lines of casters and wheels to offer you a wider range of light, medium, heavy-duty, and special-application casters for industrial and OEM products, furniture, business machines, medical equipment, retail displays, cargo handling, power towing and other material handling applications.

Flexello casters from Revvo are available in sizes ranging from 1-5/8" to 16" with load capacities from 30 lbs. to more than 10,000 lbs. Available wheel materials include nylon, rubber tire, pneumatic, cast iron, polyurethane, Flexello Superthane and Flexello Polynyl-Injection. Several of the Flexello casters feature a rugged, kingpinless design. Typical accessories and options include truck locks and expanding plugs.

### A Guide to Caster Selection

#### Load Capacity

Load capacity is the recommended maximum capacity for normal working conditions on reasonably level floor surfaces. The greater the load requirements, the larger the wheel needed. Hard-tread wheels, such as nylon and cast iron, have greater load ratings than softer-tread wheels because they do not flatten easily, and therefore roll with greater ease.

#### Floor Conditions

The wheel diameter selected should be large enough to pass over cracks, ridges, and other obstructions. To avoid floor damage, suitable wheel materials should be chosen. Wheels with tires protect surfaces and suppress noise and vibration. Solid wheels carry heavier loads and move easier on softer materials, such as carpet, but are noisier and may damage floor surfaces.

#### Bearing Seals

Bearing seals protect swivel ball races by keeping the lubricant in and dirt out.

#### Environmental Conditions

Oils, acids, chemicals, or other corrosive substances, and high or low temperatures may affect caster and wheel selection. Please consult Revvo for specific recommendations.

#### Wheel Bearings

The larger the wheel, the easier it will roll. Careful selection of the wheel bearing can improve performance. Plain bearings are designed for light and medium duty. Roller bearings significantly reduce the manual effort required to move a load.

#### Threadguards

Wheels fitted with threadguards, which remain stationary while the wheel revolves, protect against infiltration of thread, fiber, lint, or other soft, fibrous materials.

#### Brakes

Wheel brakes lock a caster wheel when foot pressure is exerted on an operating pedal which forces a brake lever against the wheel tread.



Contents	Page No.
Guide to Caster Selection .....	1
Light-Duty Casters .....	2 - 6
Low-Level Casters .....	4
Medium-Duty Casters .....	7 - 11
Heavy-Duty Casters .....	12
Special-Duty Casters .....	13 - 15
Caster Wheels .....	15 - 18

For complete technical details about casters and wheels, or to see our full product line, request the Revvo catalog.





## LM SERIES & FS SERIES

The Flexello LM Series is a light-duty swivel caster available in sizes ranging from 1-5/8" to 2-1/2" and load capacities from 31 to 51 lbs. The Flexello FS Series is a bolt-hole version of the LM Series, accommodating a 5/16" bolt. Both are ideal for store fixtures and other light-duty applications.

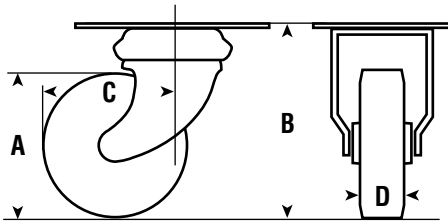

A = Wheel Diameter    B = Overall Height    C = Swivel Radius    D = Tread Width

### LM Series 1-5/8" & 2" Casters

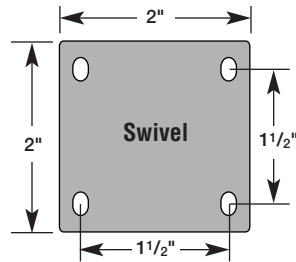

### LM Series 2-1/2" Casters

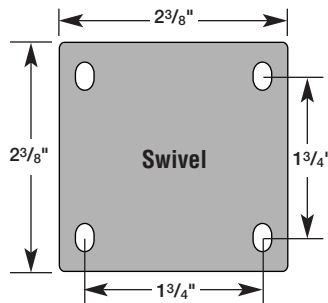

LM Series Swivel



FS Series Bolt Hole

### LM SERIES

A	B	C	D	Load Capacity	Bearing	Wheel	Swivel Part #
1-5/8"	2-1/4"	1-5/8"	3/4"	31	Plain	Gray Rubber	LM-P5814
1-5/8"	2-1/4"	1-5/8"	3/4"	31	Plain	Black Nylon	LM-E5814
2"	2-1/2"	1-3/4"	3/4"	40	Plain	Gray Rubber	LM-P2014
2"	2-1/2"	1-3/4"	3/4"	40	Plain	Black Nylon	LM-E2014
2-1/2"	3-1/4"	2"	7/8"	51	Plain	Gray Rubber	LM-P2514
2-1/2"	3-1/4"	2"	7/8"	51	Plain	Black Nylon	LM-E2514

### FS SERIES

A	B	C	D	Load Capacity	Bearing	Wheel	Swivel Part #
1-5/8"	2-1/4"	1-5/8"	3/4"	31	Plain	Gray Rubber	FS-P5813
1-5/8"	2-1/4"	1-5/8"	3/4"	31	Plain	Black Nylon	FS-N5813
2"	2-3/4"	1-3/4"	3/4"	40	Plain	Gray Rubber	FS-P2013
2"	2-3/4"	1-3/4"	3/4"	40	Plain	Black Nylon	FS-N2013

### Foot Brakes

A foot brake is available for the FS Series caster in 2" diameter only with gray rubber wheels. The swivel radius is increased to 2-1/2". To order a wheel brake, add suffix **BR** to the Swivel Part #.

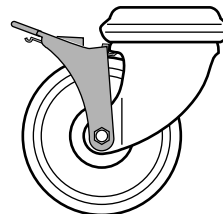

## 11 SERIES & 19 SERIES

The Flexello 11 Series and 19 Series casters are available in sizes ranging from 2-1/2" to 5" with load capacities from 125 to 264 lbs. The 11 Series is a double ball raceway swivel caster conforming to ISO standards. A bolt-hole version accommodating a 3/8" bolt is also available. The 19 Series is a fixed version of the 11 Series. These casters are designed for general work carts, bakery carts, store fixtures, and other light-duty applications.

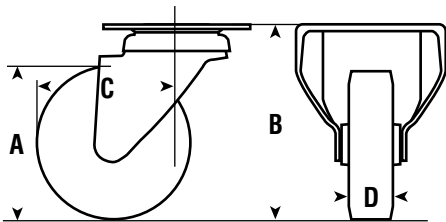

A = Wheel Diameter    B = Overall Height    C = Swivel Radius    D = Tread Width

11 Series Casters

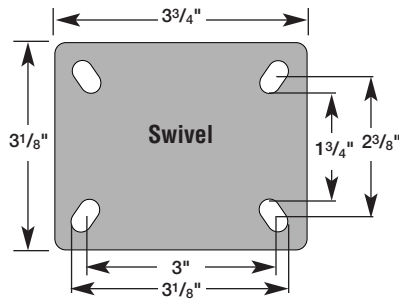

19 Series Casters

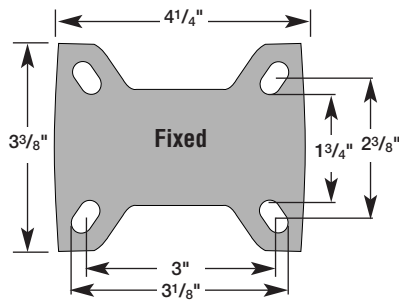

11 Series Swivel



19 Series Fixed



11 Series Bolt Hole

### 11 & 19 SERIES

A	B	C	D	Load Capacity	Bearing	Wheel	Swivel Part #	Fixed Part #
2-1/2"	3-1/2"	1-5/8"	1-3/8"	260	Plain	Nylon	25-11-NYB	N/A
3"	4-3/8"	2-3/4"	1-1/4"	154	Plain	Polypropylene	3-11-PL	N/A
3"	4-3/8"	2-3/4"	1-1/4"	154	Roller	Polypropylene	3-11-PLB	N/A
3"	4-3/8"	2-3/4"	1-1/4"	125	Plain	Rubber on Nylon	3-11-RN	N/A
4"	5"	3-3/8"	1-3/8"	198	Plain	Polypropylene	4-11-ED	4-19-ED
4"	5"	3-3/8"	1-3/8"	198	Roller	Polypropylene	4-11-EDB	4-19-EDB
4"	5"	3-3/8"	1-3/8"	132	Plain	Gray Rubber	4-11-PSW	4-19-PSW
4"	5"	3-3/8"	1-3/8"	132	Roller	Gray Rubber	4-11-PSWB	4-19-PSWB
4"	5"	3-3/8"	1-3/8"	132	Plain	Black Rubber	4-11-PS	4-19-PS
4"	5"	3-3/8"	1-3/8"	132	Roller	Black Rubber	4-11-PSB	4-19-PSB
4"	5"	3-3/8"	1-3/8"	264	Roller	Polyurethane on Nylon	4-11-PNB	4-19-PNB
5"	6-1/4"	3-7/8"	1-3/8"	198	Plain	Polypropylene	5-11-ED	5-19-ED
5"	6-1/4"	3-7/8"	1-3/8"	198	Roller	Polypropylene	5-11-EDB	5-19-EDB
5"	6-1/4"	3-7/8"	1-3/8"	176	Plain	Gray Rubber on Plastic	5-11-PSW	5-19-PSW
5"	6-1/4"	3-7/8"	1-3/8"	176	Roller	Gray Rubber on Plastic	5-11-PSWB	5-19-PSWB
5"	6-1/4"	3-7/8"	1-3/8"	176	Plain	Black Rubber on Plastic	5-11-PS	5-19-PS
5"	6-1/4"	3-7/8"	1-3/8"	176	Roller	Black Rubber on Plastic	5-11-PSB	5-19-PSB
5"	6-1/4"	3-7/8"	1-3/8"	198	Roller	Rubber-Steel Center	5-11-BSB	5-19-BSB
5"	6-1/4"	3-7/8"	1-3/8"	264	Roller	Polyurethane on Nylon	5-11-PNB	5-19-PNB

### Bolt Hole Fitting

Available with hole to suit 10mm (0.4") diameter bolt for all swivel sizes. To order, add suffix **BH10** to the Swivel Part #.

Also available with hole to suit 12mm (0.5") bolt for 4" and 5" swivel sizes. To order, add suffix **BH12** to the Swivel Part #. The bolt can be fitted down through the bolt hole, or alternatively from the underside with the wheel removed. The mounting height is 3mm (0.1") less than the top plate fitting casters.

## 11 SERIES & 19 SERIES

### Swivel & Wheel Brakes

A combined swivel and wheel brake is available for the 11 Series caster in 4" and 5" diameters. The adjustable foot-operated brake simultaneously brakes both the wheel and the swivel head. A trip pedal releases the brake. The swivel radius is increased to 5". To order a swivel and wheel brake, add suffix **SWB** to the Swivel Part #.

### Foot Brakes

A foot brake is also available for the 11 Series caster in 4" and 5" diameters. Add suffix **BR** to the Swivel Part #.

### Expanding Plugs

Plastic expanding adapters are available for the bolt-hole version. To order, add Code Suffix (as shown in the table below) to the Swivel Part #.



11 Series Swivel & Wheel Brake

EXPANDING PLUGS				
Tube Type	Code Suffix	Color	Effective Range (mm)	To Suit Tubing
Round	EXP19	White	19.0 to 20.3	7/8" x 16G
				7/8" x 18G
Round	EXP22	Gray	21.8 to 24.5	1" x 16G
				1" x 18G
				1" x 14G
Round	EXP25	Black	25.0 to 28.5	1-1/8" x 16G
				1-1/4" x 16G
				1-1/4" x 14G
Square	EXS19	White	19.0 to 20.3	7/8" x 16G
Square	EXS22	Gray	21.8 to 24.5	1" x 16G
Square	EXS25	Black	25.0 to 28.5	1-1/8" x 14G
				1" x 16G
				1-1/8" x 14G

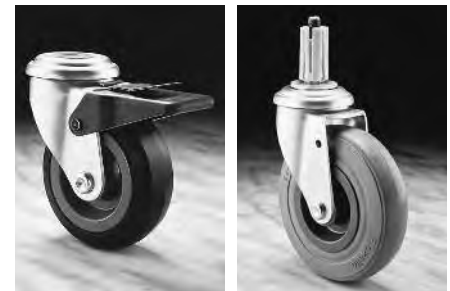

11 Series Foot Brake

11 Series Bolt Hole with Expanding Plug

# Low-Level Casters

## PN SERIES

The Flexello PN Series is a low-level swivel caster with a load capacity of 330 lbs. The wheel is fitted with a roller bearing for ease of movement, and the swivel features a double bearing raceway to handle punishment under loads. This low-level caster is designed for use on business machines, store fixtures, and general industrial applications where low caster height is desired.



PN Series Low-Level Swivel

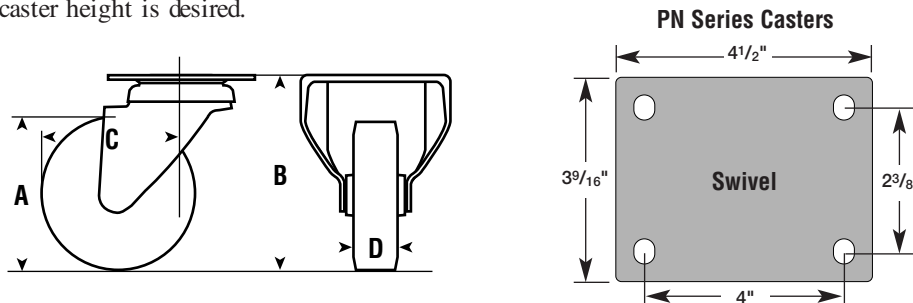

A = Wheel Diameter    B = Overall Height    C = Swivel Radius    D = Tread Width

### PN SERIES

A	B	C	D	Load Capacity	Bearing	Wheel	Swivel Part #
2-5/16"	3-3/8"	2-9/16"	1-9/16"	330	Roller	Polyurethane on Nylon	2511PNBK103



## 22 SERIES & 29 SERIES

The Flexello 22 Series and 29 Series casters are well-built, rugged models available in sizes ranging from 4" to 8" with load capacities from 308 to 880 lbs. The 22 Series is a double ball bearing swivel caster; the 29 Series is a fixed version of the 22 Series. Wheel selection changes slightly between the 4" and 5" diameter models and the 6" and 8" models, with a precision bearing available in the larger sizes. These casters are ideal for movement of general commercial and industrial dollies and other applications.

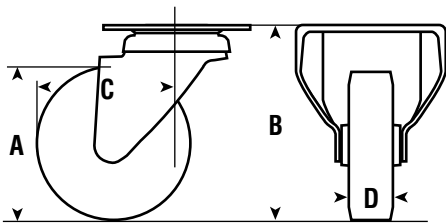

22 Series 4" & 5" Casters

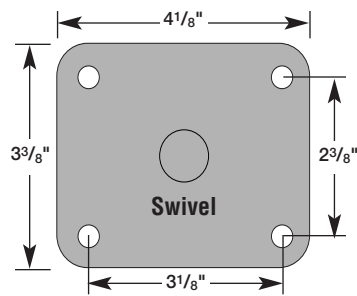

29 Series 4" & 5" Casters

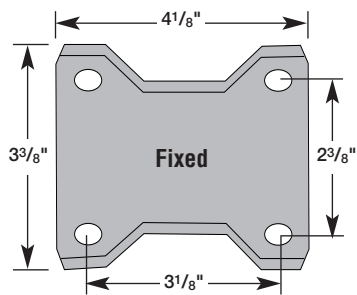

22 & 29 Series 6" & 8" Casters

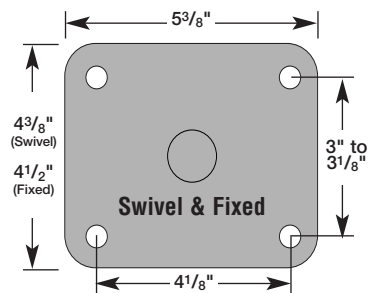

22 Series Swivel



29 Series Fixed

### Bolt Hole Fitting

Available with hole to suit 12mm (0.5") diameter bolt for 4" and 5" swivel sizes. To order, add suffix **BH12** to the Swivel Part #.

*Note: The fitting height is 5mm (0.2") lower than top plate casters, and the load rating is reduced to 353 lbs. to 441 lbs. depending on wheel type.*

### Swivel & Wheel Brakes

A combined swivel and wheel brake is available for 22 Series casters with a rectangular top plate and bolt hole fitting. The brake is on the trail side of the fork and is adjustable for different wheel types. The swivel radius is increased by 1-9/16" for 4" casters; by 1" for 5" casters; and to 6-3/8" for 6" casters. To order a swivel and wheel brake, add suffix **SWB** to the Swivel Part #.

### Foot Brakes

A foot brake is also available for the 22 Series caster in 4" and 5" diameters. To order, add suffix **BK** to the Swivel Part #.



22 Series Bolt Hole



A = Wheel Diameter    B = Overall Height    C = Swivel Radius    D = Tread Width

## 22 & 29 SERIES

A	B	C	D	Load Capacity	Bearing	Wheel	Swivel Part #	Fixed Part #
4"	5"	3-1/2"	1-1/2"	308	Plain	Blue Rubber on Nylon	4-22-RN	4-29-RN
4"	5"	3-1/2"	1-1/2"	308	Roller	Blue Rubber on Nylon	4-22-RNB	4-29-RNB
4"	5"	3-1/2"	1-1/2"	440	Plain	Polyurethane on Nylon	4-22-PN	4-29-PN
4"	5"	3-1/2"	1-1/2"	440	Roller	Polyurethane on Nylon	4-22-PNB	4-29-PNB
4"	5"	3-1/2"	1-1/2"	440	Plain	Nylon	4-22-NY	4-29-NY
4"	5"	3-1/2"	1-1/2"	440	Roller	Nylon	4-22-NYB	4-29-NYB
4"	5"	3-1/2"	1-1/2"	440	Plain	Phenolic	4-22-AN	4-29-AN
4"	5"	3-1/2"	1-1/2"	440	Roller	Phenolic	4-22-ANB	4-29-ANB
5"	6-1/8"	4-1/8"	1-1/2"	352	Plain	Blue Rubber on Nylon	5-22-RN	5-29-RN
5"	6-1/8"	4-1/8"	1-1/2"	352	Roller	Blue Rubber on Nylon	5-22-RNB	5-29-RNB
5"	6-1/8"	4-1/8"	1-1/2"	352	Plain	Black Rubber	5-22-RT	5-29-RT
5"	6-1/8"	4-1/8"	1-1/2"	352	Roller	Black Rubber	5-22-RTB	5-29-RTB
5"	6-1/8"	4-1/8"	1-1/2"	440	Plain	Polyurethane on Nylon	5-22-PN	5-29-PN
5"	6-1/8"	4-1/8"	1-1/2"	440	Roller	Polyurethane on Nylon	5-22-PNB	5-29-PNB
5"	6-1/8"	4-1/8"	1-1/2"	440	Plain	Nylon	5-22-NY	5-29-NY
5"	6-1/8"	4-1/8"	1-1/2"	440	Roller	Nylon	5-22-NYB	5-29-NYB
5"	6-1/8"	4-1/8"	1-1/2"	440	Plain	Phenolic	5-22-AN	5-29-AN
5"	6-1/8"	4-1/8"	1-1/2"	440	Roller	Phenolic	5-22-ANB	5-29-ANB
6"	7-3/8"	5"	1-1/2"	847	Plain	Nylon	6-22-NY	6-29-NY
6"	7-3/8"	5"	1-1/2"	847	Roller	Nylon	6-22-NYB	6-29-NYB
6"	7-3/8"	5"	1-1/2"	594	Plain	Rubber on Nylon	6-22-RN	6-29-RN
6"	7-3/8"	5"	1-1/2"	594	Roller	Rubber on Nylon	6-22-RNB	6-29-RNB
6"	7-3/8"	5"	1-1/2"	264	Plain	Rubber on Plastic	6-22-PS	6-29-PS
6"	7-3/8"	5"	1-1/2"	264	Roller	Rubber on Plastic	6-22-PSB	6-29-PSB
6"	7-3/8"	5"	1-1/2"	880	Plain	Polyurethane on Nylon	6-22-PN	6-29-PN
6"	7-3/8"	5"	1-1/2"	880	Roller	Polyurethane on Nylon	6-22-PNB	6-29-PNB
6"	7-3/8"	5"	1-1/2"	880	Ball Journal	Polyurethane on Nylon	6-22-PNBJ	6-29-PNBJ
6"	7-3/8"	5"	1-1/2"	264	Roller	Rubber on Steel	6-22-BSB	6-29-BSB
6"	7-3/8"	5"	1-1/2"	814	Plain	Rubber on Steel	6-22-RT	6-29-RT
6"	7-3/8"	5"	1-1/2"	814	Roller	Rubber on Cast Iron	6-22-RTB	6-29-RTB
6"	7-3/8"	5"	1-1/2"	814	Ball Journal	Rubber on Cast Iron	6-22-RTBJ	6-29-RTBJ
6"	7-3/8"	5"	1-1/2"	880	Roller	Polyurethane on Cast Iron	6-22-SUB	6-29-SUB
6"	7-3/8"	5"	1-1/2"	880	Ball Journal	Polyurethane on Cast Iron	6-22-SUBJ	6-29-SUBJ
8"	9-3/8"	6"	1-1/2"	880	Plain	Nylon	8-22-NY	8-29-NY
8"	9-3/8"	6"	1-1/2"	880	Roller	Nylon	8-22-NYB	8-29-NYB
8"	9-3/8"	6"	1-1/2"	880	Plain	Rubber on Nylon	8-22-RN	8-29-RN
8"	9-3/8"	6"	1-1/2"	880	Roller	Rubber on Nylon	8-22-RNB	8-29-RNB
8"	9-3/8"	6"	1-1/2"	396	Plain	Rubber on Plastic	8-22-PS	8-29-PS
8"	9-3/8"	6"	1-1/2"	396	Roller	Rubber on Plastic	8-22-PSB	8-29-PSB
8"	9-3/8"	6"	1-1/2"	880	Plain	Polyurethane on Nylon	8-22-PN	8-29-PN
8"	9-3/8"	6"	1-1/2"	880	Roller	Polyurethane on Nylon	8-22-PNB	8-29-PNB
8"	9-3/8"	6"	1-1/2"	880	Ball Journal	Polyurethane on Nylon	8-22-PNBJ	8-29-PNBJ
8"	9-3/8"	6"	1-1/2"	396	Roller	Rubber on Steel	8-22-BSB	8-29-BSB
8"	9-3/8"	6"	1-1/2"	880	Plain	Rubber on Cast Iron	8-22-RT	8-29-RT
8"	9-3/8"	6"	1-1/2"	880	Roller	Rubber on Cast Iron	8-22-RTB	8-29-RTB
8"	9-3/8"	6"	1-1/2"	880	Ball Journal	Rubber on Cast Iron	8-22-RTBJ	8-29-RTBJ
8"	9-3/8"	6"	1-1/2"	880	Roller	Polyurethane on Cast Iron	8-22-SUB	8-29-SUB
8"	9-3/8"	6"	1-1/2"	880	Ball Journal	Polyurethane on Cast Iron	8-22-SUBJ	8-29-SUBJ



22 Series Swivel & Wheel Brake (4" & 5")



22 Series Swivel & Wheel Brake (6" & 8")



22 Series Foot Brake

## SL SERIES & SLF SERIES

The Flexello SL Series and SLF Series casters are available in sizes ranging from 4" to 8" with load capacities from 297 to 1,400 lbs. They feature a gold color, passivated zinc finish. The SL Series is a double ball bearing swivel caster; the SLF Series is a fixed version of the SL Series. These general-duty casters are ideal for a variety of typical working conditions that may include un-level floors, cracks, gullies, door rail guides, etc.

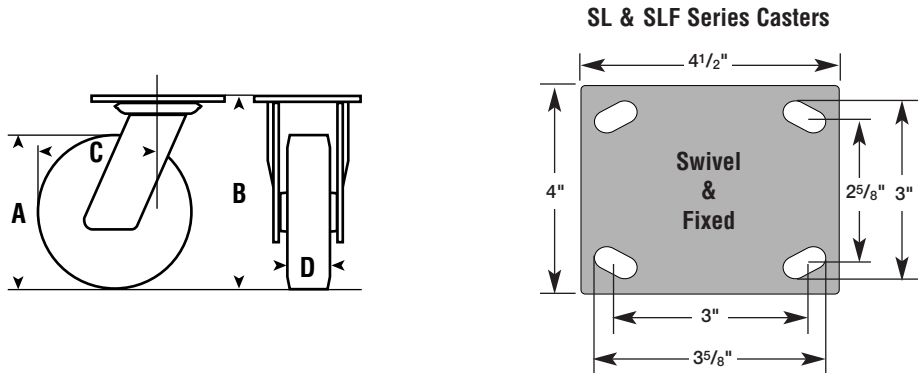

SL Series Swivel



SLF Series Fixed

### Swivel & Wheel Brakes

A combined swivel and wheel brake is available for the SL Series caster in 6" and 8" diameters. The adjustable foot-operated brake simultaneously brakes both the wheel and swivel head. A trip pedal releases the brake. The swivel radius is increased to approximately 6". To order, add suffix **SWB** to the Swivel Part #.

### Foot Brakes

A foot brake is also available for the SL Series caster in all sizes except with cast iron wheels. To order, add suffix **BK** to the Swivel Part #. (Note: the foot brake is available as a retrofit item.)

### 2-Way Directional Wheel Locks

A two-way directional lock is available to convert the SL Series swivel caster to a fixed caster by the release of a spring-loaded plunger. The directional lock attachment is independent of the caster and is secured by the caster mounting bolts. To order, add suffix **L** to the Swivel Part #. (Note: The directional lock is available as a retrofit item.)



SL Series Swivel & Wheel Brake (6" & 8")



A = Wheel Diameter    B = Overall Height    C = Swivel Radius    D = Tread Width

## SL & SLF SERIES

A	B	C	D	Load Capacity	Bearing	Wheel	Swivel Part #	Fixed Part #
4"	5-1/2"	3-1/4"	1-5/8"	297	Roller	Rubber on Steel	SL-4RTB	SLF-4RTB
4"	5-1/2"	3-1/4"	1-5/8"	550	Roller	Polyurethane on Cast Iron	SL-4SUB	SLF-4SUB
4"	5-1/2"	3-1/4"	1-1/4"	440	Roller	Nylon	SL-4NYB	SLF-4NYB
4"	5-1/2"	3-1/4"	2"	440	Roller	Phenolic	SL-4ANB	SLF-4ANB
4"	5-1/2"	3-1/4"	1-5/8"	440	Roller	Polyurethane on Nylon	SL-4PNB	SLF-4PNB
4"	5-1/2"	3-1/4"	1-1/2"	748	Roller	Cast Iron	SL-4CIB	SLF-4CIB
4"	5-1/2"	3-1/4"	2"	450	Roller	Polypropylene	SL-4PLRB	SLF-4PLRB
5"	6-1/2"	4"	1-1/2"	352	Roller	Rubber on Cast Iron	SL-5RTB	SLF-5RTB
5"	6-1/2"	4"	1-1/2"	594	Roller	Polyurethane on Cast Iron	SL-5SUB	SLF-5SUB
5"	6-1/2"	4"	1-1/2"	594	Roller	Nylon	SL-5NYB	SLF-5NYB
5"	6-1/2"	4"	2"	600	Roller	Phenolic	SL-5ANB	SLF-5ANB
5"	6-1/2"	4"	1-1/2"	550	Roller	Polyurethane on Nylon	SL-5PNB	SLF-5PNB
5"	6-1/2"	4"	1-5/8"	990	Roller	Cast Iron	SL-5CIB	SLF-5CIB
5"	6-1/2"	4"	2"	650	Roller	Polypropylene	SL-5PLRB	SLF-5PLRB
5"	6-1/2"	4"	1-1/2"	352	Roller	Rubber on Nylon	SL-5RNB	SLF-5RNB
6"	7-1/2"	4-3/4"	1-3/4"	814	Roller	Rubber on Cast Iron	SL-6RTB	SLF-6RTB
6"	7-1/2"	4-3/4"	1-3/4"	814	Ball Journal	Rubber on Cast Iron	SL-6RTBJ	SLF-6RTBJ
6"	7-1/2"	4-3/4"	1-3/4"	990	Roller	Polyurethane on Cast Iron	SL-6SUB	SLF-6SUB
6"	7-1/2"	4-3/4"	1-3/4"	990	Ball Journal	Polyurethane on Cast Iron	SL-6SUBJ	SLF-6SUBJ
6"	7-1/2"	4-3/4"	1-1/2"	847	Roller	Nylon	SL-6NYB	SLF-6NYB
6"	7-1/2"	4-3/4"	2"	1200	Roller	Phenolic	SL-6ANRB	SLF-6ANRB
6"	7-1/2"	4-3/4"	1-3/4"	990	Roller	Polyurethane on Nylon	SL-6PNB	SLF-6PNB
6"	7-1/2"	4-3/4"	1-3/4"	990	Ball Journal	Polyurethane on Nylon	SL-6PNBJ	SLF-6PNBJ
6"	7-1/2"	4-3/4"	1-3/4"	1200	Roller	Cast Iron	SL-6CIB	SLF-6CIB
6"	7-1/2"	4-3/4"	2"	750	Roller	Polypropylene	SL-6PLRB	SLF-6PLRB
6"	7-1/2"	4-3/4"	1-3/4"	594	Roller	Rubber on Nylon	SL-6RNB	SLF-6RNB
8"	9-1/2"	6-1/8"	2"	990	Roller	Rubber on Cast Iron	SL-8RTB	SLF-8RTB
8"	9-1/2"	6-1/8"	2"	990	Ball Journal	Rubber on Cast Iron	SL-8RTBJ	SLF-8RTBJ
8"	9-1/2"	6-1/8"	2"	990	Roller	Polyurethane on Cast Iron	SL-8SUB	SLF-8SUB
8"	9-1/2"	6-1/8"	2"	990	Ball Journal	Polyurethane on Cast Iron	SL-8SUBJ	SLF-8SUBJ
8"	9-1/2"	6-1/8"	1-1/2"	847	Roller	Nylon	SL-8NYB	SLF-8NYB
8"	9-1/2"	6-1/8"	2"	1400	Roller	Phenolic	SL-8ANRB	SLF-8ANRB
8"	9-1/2"	6-1/8"	2"	990	Roller	Polyurethane on Nylon	SL-8PNB	SLF-8PNB
8"	9-1/2"	6-1/8"	2"	990	Ball Journal	Polyurethane on Nylon	SL-8PNBJ	SLF-8PNBJ
8"	9-1/2"	6-1/8"	1-3/4"	1400	Roller	Cast Iron	SL-8CIB	SLF-8CIB
8"	9-1/2"	6-1/8"	2"	1000	Roller	Polypropylene	SL-8PLRB	SLF-8PLRB
8"	9-1/2"	6-1/8"	2"	880	Ball Journal	Rubber on Nylon	SL-8RNB	SLF-8RNB



SL Series Foot Brake (4" to 8")



SL Series Directional Lock

### 55 SERIES & 88 SERIES

The Flexello 55 Series and 88 Series casters are available in sizes of 6" and 8" with load capacities ranging from 814 to 1,595 lbs. A leading choice among industrial casters, the 55 Series swivel and 88 Series fixed casters are recognized worldwide for a unique design offering high-capacity in a pressed steel caster. They are designed for moving loads over rough floors and in difficult environments.

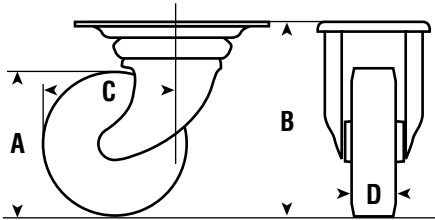

A = Wheel Diameter    B = Overall Height    C = Swivel Radius    D = Tread Width

55 Series Casters

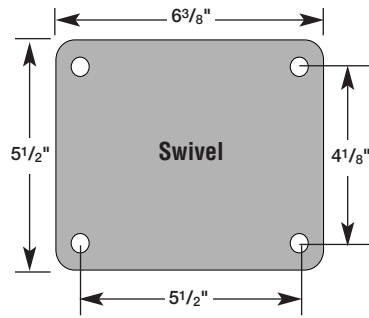

88 Series Casters

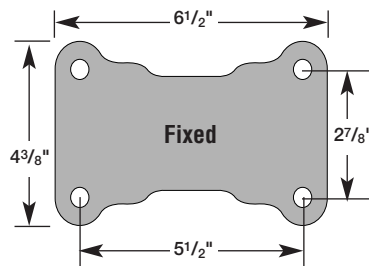

55 Series Swivel



88 Series Fixed



55 Series Swivel & Wheel Brake

55 & 88 SERIES									
A	B	C	D	Load Capacity	Bearing	Wheel	Swivel Part #	Fixed Part #	
6"	7-3/4"	4-3/8"	1-3/4"	814	Plain	Rubber on Cast Iron	6-55-RT	6-88-RT	
6"	7-3/4"	4-3/8"	1-3/4"	814	Roller	Rubber on Cast Iron	6-55-RTB	6-88-RTB	
6"	7-3/4"	4-3/8"	1-3/4"	1386	Roller	Polyurethane on Cast Iron	6-55-SUB	6-88-SUB	
6"	7-3/4"	4-3/8"	1-3/4"	847	Plain	Nylon	6-55-NY	6-88-NY	
6"	7-3/4"	4-3/8"	1-3/4"	847	Roller	Nylon	6-55-NYB	6-88-NYB	
6"	7-3/4"	4-3/8"	1-3/4"	880	Roller	Phenolic	6-55-ANB	6-88-ANB	
6"	7-3/4"	4-3/8"	1-3/4"	1496	Plain	Cast Iron	6-55-CI	6-88-CI	
6"	7-3/4"	4-3/8"	1-3/4"	1496	Roller	Cast Iron	6-55-CIB	6-88-CIB	
8"	9-5/8"	6"	2"	1177	Plain	Rubber on Cast Iron	8-55-RT	8-88-RT	
8"	9-5/8"	6"	2"	1177	Roller	Rubber on Cast Iron	8-55-RTB	8-88-RTB	
8"	9-5/8"	6"	2"	1595	Roller	Polyurethane on Cast Iron	8-55-SUB	8-88-SUB	
8"	9-5/8"	6"	2"	990	Plain	Nylon	8-55-NY	8-88-NY	
8"	9-5/8"	6"	2"	990	Roller	Nylon	8-55-NYB	8-88-NYB	
8"	9-5/8"	6"	2"	1188	Roller	Phenolic	8-55-ANB	8-88-ANB	
8"	9-5/8"	6"	2"	1595	Plain	Cast Iron	8-55-CI	8-88-CI	
8"	9-5/8"	6"	2"	1595	Roller	Cast Iron	8-55-CIB	8-88-CIB	

### Swivel & Wheel Brakes

A combined swivel and wheel brake is available for the 55 Series caster with a roller bearing and a Rubber-on-Cast-Iron or a Polyurethane-on-Cast-Iron wheel. The swivel radius is increased to approximately 6-3/16". To order, add suffix **SWB** to the Swivel Part #.

## GT SERIES & GTF SERIES

The Flexello GF Series swivel and GTF Series fixed casters are available in sizes ranging from 6" to 10" with load capacities from 814 to 2,200 lbs. Featuring a rugged kingpinless design, these casters are ideal for handling power towing applications. Wheel options include Rubber on Cast Iron, Flexello Polyurethane on Cast Iron, Cast Iron and Phenolic for a variety of average-to-optimum working floor conditions.

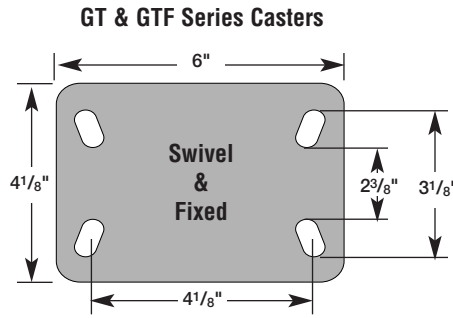
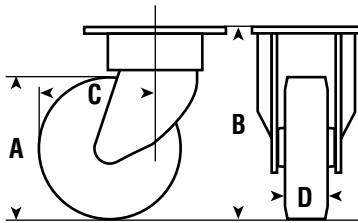

A = Wheel Diameter    B = Overall Height    C = Swivel Radius    D = Tread Width

### GT & GTF SERIES

A	B	C	D	Load Capacity	Bearing	Wheel	Swivel Part #	Fixed Part #
6"	8"	5-7/8"	1-3/4"	814	Roller	Rubber on Cast Iron	GT-6RTB	GTF-6RT
6"	8"	5-7/8"	1-3/4"	814	Ball Journal	Rubber on Cast Iron	GT-6RTBJ	GTF-6RTBJ
6"	8"	5-7/8"	1-3/4"	1386	Roller	Polyurethane on Cast Iron	GT-6SUB	GTF-6SUB
6"	8"	5-7/8"	1-3/4"	1386	Ball Journal	Polyurethane on Cast Iron	GT-6SUBJ	GTF-6SUBJ
6"	8"	5-7/8"	1-3/4"	1386	Taper Roller	Polyurethane on Cast Iron	GT-6SUTM	GTF-6SUTM
6"	8"	5-7/8"	1-3/4"	1200	Roller	Phenolic	GT-6ANB	GTF-6ANB
6"	8"	5-7/8"	1-3/4"	1804	Roller	Cast Iron	GT-6CIB	GTF-6CIB
8"	10"	7-1/4"	2"	1177	Roller	Rubber on Cast Iron	GT-8RTB	GTF-8RTB
8"	10"	7-1/4"	2"	1177	Ball Journal	Rubber on Cast Iron	GT-8RTBJ	GTF-8RTBJ
8"	10"	7-1/4"	2"	2090	Roller	Polyurethane on Cast Iron	GT-8SUB	GTF-8SUB
8"	10"	7-1/4"	2"	2090	Ball Journal	Polyurethane on Cast Iron	GT-8SUBJ	GTF-8SUBJ
8"	10"	7-1/4"	2"	2090	Taper Roller	Polyurethane on Cast Iron	GT-8SUTM	GTF-8SUTM
8"	10"	7-1/4"	2"	1400	Roller	Phenolic	GT-8ANB	GTF-8ANB
8"	10"	7-1/4"	1-3/4"	2000	Roller	Cast Iron	GT-8CIB	GTF-8CIB
10"	12"	7-3/8"	2"	1350	Roller	Rubber on Cast Iron	GT-10RTB	GTF-10RTB
10"	12"	7-3/8"	2"	1350	Ball Journal	Rubber on Cast Iron	GT-10RTBJ	GTF-10RTBJ
10"	12"	7-3/8"	2"	2200	Roller	Polyurethane on Cast Iron	GT-10SUB	GTF-10SUB
10"	12"	7-3/8"	2"	2200	Ball Journal	Polyurethane on Cast Iron	GT-10SUBJ	GTF-10SUBJ
10"	12"	7-3/8"	2"	2200	Taper Roller	Polyurethane on Cast Iron	GT-10SUTM	GRF-10SUTM
10"	12"	7-3/8"	2"	2200	Roller	Cast Iron	GT-10CIB	GTF-10CIB

### Foot Brakes

A foot brake is available for the GT Series caster in 8" and 10" diameters with Rubber-on-Cast-Iron or a Polyurethane-on-Cast-Iron wheel. The swivel radius is increased to 6" on 6" diameter wheels only. To order a foot brake, add suffix **BR** to the Swivel Part #.

### 2-Way Directional Wheel Lock

A two-way directional wheel lock is available to convert the GT Series swivel caster to a fixed caster by the release of a spring-loaded plunger. The locked direction of travel is in line with the longer side of the top plate. To order a directional lock, add suffix **L** to the Swivel Part #.



GT Series Swivel



GTF Series Fixed



GT Series 2-Way Directional Lock





### KV SERIES & KVF SERIES

The Flexello KV Series and KVF Series casters are available in sizes ranging from 6" to 12" with load capacities from 814 to 3,000 lbs. The KV Series is a taper roller and ball bearing swivel caster; the KVF is a fixed version of the KV Series. These medium and heavy-duty casters are designed for a variety of applications in average-to-optimum working floor conditions.

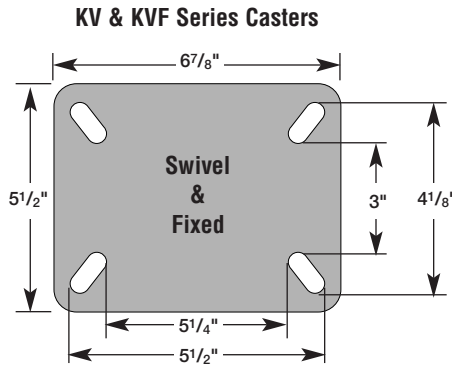

KV Series Swivel



KVF Series Fixed

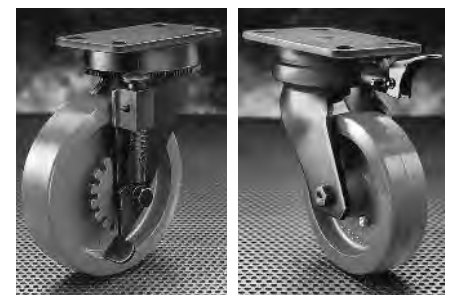

KV Series Swivel & Wheel Brake (8") - Available with Polyurethane-on-Cast-Iron wheel only; add suffix **CWL** to Swivel Part #.

KV Series 2-Way Directional Lock (6" to 10") - Add suffix **L** to Swivel Part #.

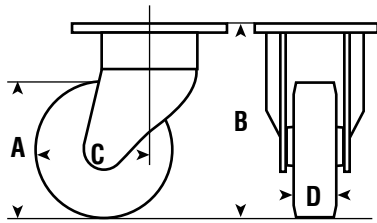

A = Wheel Diameter    B = Overall Height    C = Swivel Radius    D = Tread Width

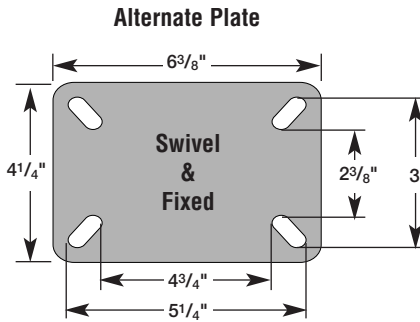

#### KV & KVF SERIES

A	B	C	D	Load Capacity	Bearing	Wheel	Swivel Part #	Fixed Part #
6"	8-3/8"	5-1/4"	1-3/4"	814	Roller	Rubber on Cast Iron	KV-6RTBM4	KVF-6RTBM4
6"	8-3/8"	5-1/4"	1-3/4"	814	Ball Journal	Rubber on Cast Iron	KV-6RTBJM4	KVF-6RTBJM4
6"	8-3/8"	5-1/4"	1-3/4"	1386	Roller	Polyurethane on Cast Iron	KV-6SUBM4	KVF-6SUBM
6"	8-3/8"	5-1/4"	1-3/4"	1386	Ball Journal	Polyurethane on Cast Iron	KV-6SUBJM4	KVF-6SUBJM4
6"	8-3/8"	5-1/4"	1-3/4"	1386	Taper Roller	Polyurethane on Cast Iron	KV-6SUTMM4	KVF-6SUBJM4
6"	8-3/8"	5-1/4"	1-3/4"	2002	Roller	Cast Iron	KV-6CIBM4	KVF-6CIBM4
8"	10-3/8"	6-3/8"	2"	1177	Roller	Rubber on Cast Iron	KV-8RTBM4	KVF-8RTBM4
8"	10-3/8"	6-3/8"	2"	1177	Ball Journal	Rubber on Cast Iron	KV-8RTBJM4	KVF-8RTBJM4
8"	10-3/8"	6-3/8"	2"	2090	Roller	Polyurethane on Cast Iron	KV-8SUBM4	KVF-8SUBM4
8"	10-3/8"	6-3/8"	2"	2090	Ball Journal	Polyurethane on Cast Iron	KV-8SUBJM4	KVF-8SUBJM4
8"	10-3/8"	6-3/8"	2"	2090	Taper Roller	Polyurethane on Cast Iron	KV-8SUTMM4	KVF-8SUTMM4
8"	10-3/8"	6-3/8"	3"	2398	Ball Journal	Polyurethane on Cast Iron	KV-83SUTMM4	KVF-83SUTMM4
8"	10-3/8"	6-3/8"	1-3/4"	2200	Roller	Cast Iron	KV-8CIBM4	KVF-8CIBM4
10"	12-3/8"	7-3/8"	2"	1350	Roller	Rubber on Cast Iron	KV-10RTBM4	KVF-RTBM4
10"	12-3/8"	7-3/8"	2"	1350	Ball Journal	Rubber on Cast Iron	KV-10RTBJM4	KVF-10RTBJM4
10"	12-3/8"	7-3/8"	2"	2300	Roller	Polyurethane on Cast Iron	KV-10SUBM4	KVF-10SUBM4
10"	12-3/8"	7-3/8"	2"	2300	Ball Journal	Polyurethane on Cast Iron	KV-10SUBJM4	KVF-10SUBJM4
10"	12-3/8"	7-3/8"	2"	2300	Taper Roller	Polyurethane on Cast Iron	KV-10SUTMM4	KVF-10SUTMM4
10"	12-3/8"	7-3/8"	2"	2400	Roller	Cast Iron	KV-10CIBM4	KVF-10CIBM4
10"	12-3/8"	7-3/8"	3"	3000	Taper Roller	Polyurethane on Cast Iron	KV-103SUTMM4	KVF-103SUTMM4
12"	14-3/8"	8-1/4"	2-1/4"	1500	Roller	Rubber on Cast Iron	KV-12RTBM4	KVF-12RTBM4
12"	14-3/8"	8-1/4"	2-1/4"	1500	Ball Journal	Rubber on Cast Iron	KV-12RTBJM4	KVF-12RTBJM4
12"	14-3/8"	8-1/4"	2-1/4"	2400	Roller	Polyurethane on Cast Iron	KV-12SUBM4	KVF-12SUBM4
12"	14-3/8"	8-1/4"	2-1/4"	2400	Ball Journal	Polyurethane on Cast Iron	KV-12SUBJM4	KVF-12SUBJM4
12"	14-3/8"	8-1/4"	2-1/4"	2400	Taper Roller	Polyurethane on Cast Iron	KV-12SUTMM4	KVF-12SUTMM4

## EH SERIES & EHF SERIES

The Flexello EF Series swivel and EHF Series fixed casters are available in sizes ranging from 6" to 16" with load capacities from 2,400 to 11,990 lbs. These heavy-duty casters are ideal for handling power towing applications at approximately 4 mph. Wheel options include Cast Iron and Flexello Polyurethane on Cast Iron.

EH & EHF Series 6" to 12" Casters

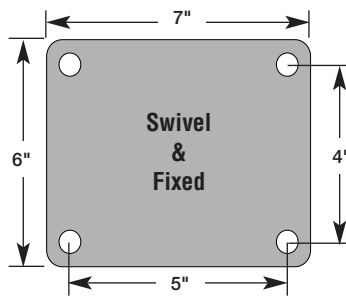

EH & EHF Series 10" & 16" Casters with 9,000+ lbs. Load Capacity

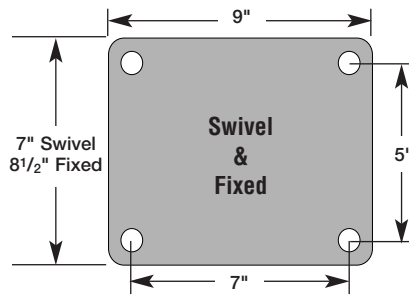

EH Series Swivel



EHF Series Fixed



EH Series 2-Way Directional Lock

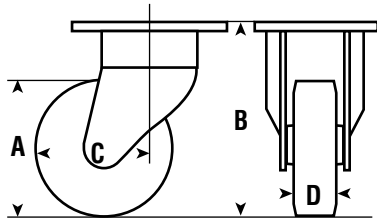

A = Wheel Diameter    B = Overall Height    C = Swivel Radius    D = Tread Width

### EH & EHF SERIES

A	B	C	D	Load Capacity	Bearing	Wheel	Swivel Part #	Fixed Part #
6"	10-3/8"	5-3/4"	2-3/4"	6490	Taper Roller	Cast Iron	EH-306HCTM	EHF-306HCTM
8"	12"	6-3/4"	3"	2400	Taper Roller	Polyurethane on Cast Iron	EH-108SUTM	EHF-108SUTM
10"	14"	7-3/4"	3"	3500	Taper Roller	Polyurethane on Cast Iron	EH-110SUTM	EHF-110SUTM
10"	14-1/2"	7-3/4"	3"	5000	Taper Roller	Polyurethane on Cast Iron	EH-210SUTM	EHF-210SUTM
10"	14-1/2"	7-3/4"	3"	6490	Taper Roller	Cast Iron	EH-310HCTM	EHF-310HCTM
10"	16"	8-1/4"	4"	11990	Taper Roller	Cast Iron	EH-510HCTM	EHF-510HCTM
12"	16-5/8"	8-3/4"	3"	5000	Taper Roller	Polyurethane on Cast Iron	EH-212SUTM	EHF-210SUTM
12"	16-5/8"	8-3/4"	4"	6490	Taper Roller	Polyurethane on Cast Iron	EH-312SUTM	EHF-312SUTM
12"	16-5/8"	9-3/8"	4"	3960	Taper Roller	Rubber on Cast Iron	EH-312RTTM40	EHF-312RTTM40
16"	21-3/4"	11-1/4"	5"	9966	Taper Roller	Polyurethane on Cast Iron	EH-516SUTM	EHF-516SUTM

### 2-Way Directional Wheel Locks

A two-way directional wheel lock is available for the EH Series 210 model (10") and 212 and 312 model (12") swivel casters. (Other models are available on special order.) Converts swivel casters to fixed casters by the release of a spring-loaded plunger. The locked direction of travel is in line with the longer side of the top plate. To order a directional lock, add suffix **L** to the Swivel Part #.



Expanding Hub Brake

### Expanding Hub Brakes

Expanding hub brakes are available on special order for EHF Series fixed casters (consult Revvo for sizes and models). To order an expanding hub brake, add suffix **BR** to the Fixed Part #. Also specify **LH** for left-handed or **RH** for right-handed hub brake.

### JA SERIES

The Flexello JA Series swivel jacking casters are available in sizes ranging from 6" to 10" with load capacities from 880 to 5,500 lbs. The 6" and 8" models have a screw jacking system with a 3" lift independent of the swiveling action. The 10" model has a 6" lift and features a 2-way directional lock with travel at 90° to the vertical fixing plate. These heavy-duty casters are designed to facilitate movement and quick, accurate adjustment of working platforms, machines, and other applications.

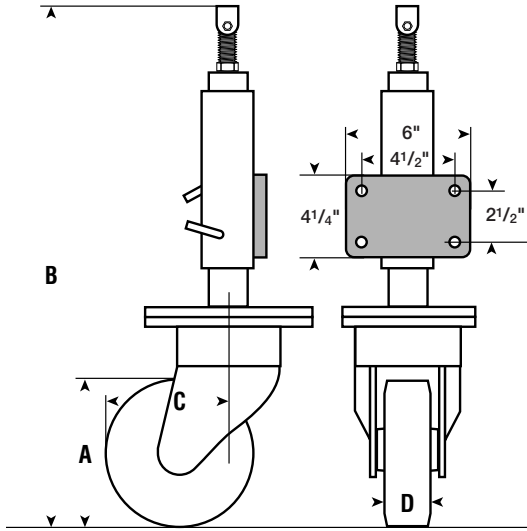

Plate dimensions shown for 6" and 8" diameter models. The bolt-hole pattern for 10" diameter models measures 4" by 4". Consult the factory for additional details on 10" models.

A = Wheel Diameter    B = Overall Height    C = Swivel Radius    D = Tread Width



JA Series with 3" Lift

JA SERIES								
A	B	C	D	Load Capacity	Bearing	Wheel	Swivel Part #	Fixed Part #
6"	21-7/8"	5-3/8"	1-3/4"	880	Roller	Rubber on Cast Iron	JA-6RTB	N/A
6"	21-7/8"	5-3/8"	1-3/4"	1600	Roller	Polyurethane on Cast Iron	JA-6SUB	N/A
6"	21-7/8"	5-3/8"	1-3/4"	2240	Roller	Cast Iron	JA-6CIB	N/A
8"	23-7/8"	6-3/8"	2"	1285	Roller	Rubber on Cast Iron	JA-8RTB	N/A
8"	23-7/8"	6-3/8"	2"	2300	Roller	Polyurethane on Cast Iron	JA-8SUB	N/A
8"	23-7/8"	6-3/8"	2"	2400	Roller	Cast Iron	JA-8CIB	N/A
10"	29-3/8"	7-3/4"	3"	5500	Ball Journal	Polyurethane on Cast Iron	JA-210SUTML	N/A

### TLCH SERIES

Flexello TLCH Series floor locks provide a ready means of instantly securing a truck or other mobile equipment in a fixed position without raising it. The TLCH Series floor lock bolts to the underside of a truck with its top face exactly 7-7/8" above the ground to ensure optimum performance. Complete freedom of movement is restored by using the foot pedal. TLCH floor locks feature an electrostatic-sprayed black matte finish.

TLCH SERIES				
Top Plate Overall	Bolt Pattern	Overall Height (Free Position)	Overall Height (Pad Extended)	Part Number
6" x 4-1/2"	5" x 2-1/2"	6-3/8"	8-1/8"	TLCH



TLCH Series Floor Locks



## TOWCASTERS

Flexello Towcasters are provided in sets of four heavy-duty fabricated casters and are available in sizes of 10" and 12" with load capacities of 22,000 lbs. and 26,400 lbs. per set respectively. The Flexello Towcaster system is designed to move ISO freight containers quickly and easily without the use of expensive equipment such as cranes, gantries, or side-loading forks.

The Flexello Towcaster system includes two swivel and two fixed casters featuring adapter plates that lock positively (via quick-action securing screws) into the corner castings incorporated into all ISO freight containers. A special lifting handle and ratchet spanner, included in the set, facilitate easy lifting and locking. Spare parts for Towcaster are available on request.

Available optionally in sets of two, the patented Flexello Towbar enables towing by tractor, fork truck or other towing vehicle. It measures 8 feet long and fits easily and securely into the ISO container corner brackets immediately above the swivel Towcasters. The Towbars attach to the towing vehicle using standard link pins up to 1-1/2" diameter (not supplied).

TOWCASTER	SET #1	SET #2
Wheel Diameter	10"	12"
Tread Width	3"	4"
Mounting Height	15-3/4"	17-7/8"
Load Capacity	22,000 lbs.	26,400 lbs.
Wheel Type	Polyurethane on Cast Iron	Polyurethane on Cast Iron
Part #	ISO-210SUTM	ISO-312SUTM



Towcaster Locking Screws, Lifting Handle, Ratchet Spanner and the optional Towbar.



Swivel Towcaster



Fixed Towcaster

## UTP SERIES

The Flexello UTP Series is a combination twin-wheel swivel caster and leveling foot. It features an adjustable stem and foot for leveling that is concentric with the caster spindle. The body is constructed of high-impact nylon for strength and appearance. The stem is made of sturdy carbon steel. The UTP Series caster is ideal for appliance cabinets, medical carts and furniture, racks, displays, and other heavy equipment requiring period rolling and level, stationary positioning. The UTP Series caster is available in standard black and custom colors. Other options include a top plate design, foot brake, and directional lock.

### UTP SERIES

Wheel Diameter	2-5/8"
Minimum Height*	4-15/16"
Maximum Height**	5-1/2"
Height Adjustment	9/16"
Foot Diameter	1-1/8"
Swivel Radius	2-1/8"
Overall Width	2-7/8"
Tread Width	11/16"
Load Capacity	330 lbs.
Bearing	Ball Raceway
Wheel Type	Nylon 6
Swivel Part #	UTP-066BNOP

\* Minimum clearance of 3/8" between the foot and floor when the stem is raised for rolling.

\*\* Maximum clearance 9/16" between the wheel and floor when the stem is lowered for leveling.



UTP Series - Adjustable Stem & Foot

## WNY SERIES NYLON WHEELS

The Flexello WNY Series nylon wheels are available in sizes ranging from 2" to 8" with load capacities from 90 to 990 lbs. Hard tread. Natural color finish.

### WNY SERIES

Wheel Diameter	Tread Width	Shaft Diameter*	Hub Length	Load Capacity	Bearing	Wheel Part #
2"	3/4"	1/4"	1"	90	Plain	WNY-20
2-1/2"	7/8"	3/8"	1-5/16"	180	Plain	WNY-25
3"	1"	12 mm	40 mm	253	Plain	WNY-3M12
4"	1-1/4"	15 mm	48 mm	440	Plain	WNY-4M15
4"	1-1/4"	15 mm	48 mm	440	Roller	WNY-4RBM15
5"	1-3/8"	15 mm	48 mm	594	Plain	WNY-5M15
5"	1-3/8"	15 mm	48 mm	594	Roller	WNY-5RBM15
6"	1-1/2"	20 mm	60 mm	847	Plain	WNY-6M20
6"	1-1/2"	20 mm	60 mm	847	Roller	WNY-6RBM20
6"	1-1/2"	1"	60 mm	847	Plain	WNY-6L
8"	1-1/2"	20 mm	60 mm	990	Plain	WNY-8M20
8"	1-1/2"	20 mm	60 mm	990	Roller	WNY-8RBM20
8"	1-1/2"	1"	2-3/8"	990	Plain	WNY-8L

\* Revvo supplies bushings to adapt metric shaft diameters to Imperial/inches.



WNY Series Nylon Wheels

## WRN SERIES RUBBER-ON-NYLON WHEELS

The Flexello WRN Series blue rubber tire/nylon center wheels are available in sizes ranging from 2" to 8" with load capacities from 50 to 880 lbs. Resilient tread. Black finish.

### WRN SERIES

Wheel Diameter	Tread Width	Shaft Diameter*	Hub Length	Load Capacity	Bearing	Wheel Part #
2"	7/8"	1/4"	1"	50	Plain	WRN-20
2-1/2"	1"	3/8"	1-7/16"	88	Plain	WRN-25
3"	1-7/16"	12 mm	1-9/16"	165	Plain	WRN-3M12
4"	1-1/2"	15 mm	1-7/8"	308	Plain	WRN-4M15
4"	1-1/2"	15 mm	1-7/8"	308	Roller	WRN-4RBM15
5"	1-1/2"	15 mm	1-7/8"	352	Plain	WRN-5M15
5"	1-1/2"	15 mm	1-7/8"	352	Roller	WRN-5RBM15
6"	1-3/4"	20 mm	2-3/8"	594	Plain	WRN-6M20
6"	1-3/4"	20 mm	2-3/8"	594	Roller	WRN-6RBM20
8"	2"	20 mm	2-3/8"	880	Plain	WRN-8M20
8"	2"	20 mm	2-3/8"	880	Roller	WRN-8RBM20

\* Revvo supplies bushings to adapt metric shaft diameters to Imperial/inches.



WRN Series Rubber-on-Nylon Wheels

## WHC SERIES EXTRA-HEAVY CAST-IRON WHEELS

The Flexello WHC Series extra-heavy-duty, cast-iron wheels are available in sizes of 6" and 10" with load capacities of 6,400 lbs. and 11,990 lbs. respectively. Black finish.

### WHC SERIES

Wheel Diameter	Tread Width	Shaft Diameter*	Hub Length	Load Capacity	Bearing	Wheel Part #
6"	2-3/4"	1-1/4"	3-5/8"	6400	Taper Roller	WHC-306TM
10"	3"	1-1/4"	3-5/8"	6400	Taper Roller	WHC-310TM
10"	4"	1-3/8"	5-7/8"	11990	Taper Roller	WHC-510TM

\* Revvo supplies bushings to adapt metric shaft diameters to Imperial/inches.



WHC Series Cast-Iron Wheels

## WRT SERIES RUBBER ON CAST-IRON WHEELS

The Flexello WRT Series rubber tire/cast-iron center wheels are available in sizes ranging from 4" to 12" with load capacities from 297 to 3,960 lbs. Resilient tread. Black finish.

### WRT SERIES

Wheel Diameter	Tread Width	Shaft Diameter*	Hub Length	Load Capacity	Bearing	Wheel Part #
4"	1-5/8"	15 mm	1-7/8"	297	Roller	WRT-4RBM15
5"	1-1/2"	15 mm	1-7/8"	350	Roller	WRT-5RBM15
6"	1-3/4"	20 mm	2-3/8"	814	Roller	WRT-6RBM20
6"	1-3/4"	25 mm	2-3/8"	814	Roller	WRT-6RBM25
6"	1-3/4"	1"	2-3/8"	814	Roller	WRT-6LRB
6"	1-3/4"	12 mm	2-3/8"	814	Ball Journal	WRT-6BJM12
6"	1-3/4"	20 mm	2-3/8"	814	Ball Journal	WRT-6BJM20
6"	1-3/4"	25 mm	2-3/8"	814	Ball Journal	WRT-6BJM25
8"	2"	20 mm	2-3/8"	1177	Roller	WRT-8RBM20
8"	2"	25 mm	2-3/8"	1177	Roller	WRT-8RBM25
8"	2"	1"	2-3/8"	1177	Roller	WRT-8LRB
8"	2"	12 mm	2-3/8"	1177	Ball Journal	WRT-8BJM12
8"	2"	20 mm	2-1/4"	1177	Ball Journal	WRT-8BJM20
8"	2"	25 mm	2-1/4"	1177	Ball Journal	WRT-8BJM25
10"	2"	25 mm	2-3/8"	1353	Roller	WRT-10RBM25
10"	2"	1"	2-3/8"	1353	Roller	WRT-10RB
10"	2"	1-1/4"	2-3/8"	1353	Roller	WRT-10LRB
10"	2"	12 mm	2-3/8"	1353	Ball Journal	WRT-10BJM12
10"	2"	25 mm	2-1/4"	1353	Ball Journal	WRT-10BJM25
12"	2-1/4"	25 mm	2-3/8"	1500	Roller	WRT-12RBM25
12"	2-1/4"	1"	2-3/8"	1500	Roller	WRT-12RB
12"	2-1/4"	1-1/4"	2-3/8"	1500	Roller	WRT-12LRB
12"	2-1/4"	12 mm	2-3/8"	1500	Ball Journal	WRT-12BJM12
12"	2-1/4"	25 mm	2-1/4"	1500	Ball Journal	WRT-12BJM25
12"	4"	1-1/4"	4-5/8"	3960	Taper Roller	WRT-312TM40

\* Revvo supplies bushings to adapt metric shaft diameters to Imperial/inches.



WRT Series Rubber-on-Cast-Iron Wheels

## WAN SERIES PHENOLIC WHEELS

The Flexello WAN Series reinforced phenolic wheels are available in sizes ranging from 3" to 8" with load capacities from 500 to 1,400 lbs. WAN wheels are available in 4" and 5" diameters for high-temperature applications (up to 482°F/250°C) with 50% reduced load ratings. Please consult factory. Hard tread. Black finish.

### WAN SERIES

Wheel Diameter	Tread Width	Shaft Diameter	Hub Length	Load Capacity	Bearing	Wheel Part #
3"	1-1/2"	3/4"	1-5/8"	500	Roller	WAN-3RB
3"	1-1/2"	1/2"	1-5/8"	500	Plain	WAN-3M12
4"	2"	3/4"	2-3/16"	800	Roller	WAN-4RB
4"	1-1/2"	1/2"	1-5/8"	600	Plain	WAN-4M15
5"	2"	3/4"	2-3/16"	1000	Roller	WAN-5RB
6"	2"	3/4"	1-9/16"	1200	Roller	WAN-6RB
8"	2"	3/4"	2-3/16"	1400	Roller	WAN-8RB



WAN Series Phenolic Wheels





## WSU SERIES SUPERTHANE WHEELS

The Flexello WSU Series “Superthane” polyurethane tire/cast-iron center, heavy-duty wheels are available in sizes from 3" to 16" with load capacities from 250 to 9,966 lbs.

### WSU SERIES

Wheel Diameter	Tread Width	Shaft Diameter*	Hub Length	Load Capacity	Bearing	Wheel Part #
3"	1-1/8"	12 mm	1-9/16"	250	Plain	WSU-3M12
4"	1-5/8"	15 mm	1-7/8"	550	Roller	WSU-4RBM15
5"	1-3/8"	15 mm	1-7/8"	594	Roller	WSU-5RBM15
5"	1-3/8"	25 mm	1-7/8"	594	Roller	WSU-5RBM25
5"	1-3/8"	1"	1-7/8"	594	Roller	WSU-5LRB
6"	1-1/2"	20 mm	2-3/8"	990	Roller	WSU-61RBM20
6"	1-3/4"	20 mm	2-3/8"	1386	Roller	WSU-6RBM20
6"	1-3/4"	25 mm	2-3/8"	1386	Roller	WSU-6RBM25
6"	1-3/4"	1"	2-3/8"	1386	Roller	WSU-6LRB
6"	1-3/4"	12 mm	2-3/8"	1386	Ball Journal	WSU-6BJM12
6"	1-3/4"	20 mm	2-1/4"	1386	Ball Journal	WSU-6BJM20
6"	1-3/4"	25 mm	2-1/4"	1386	Ball Journal	WSU-6BJM25
6"	1-3/4"	1/2"	2-3/8"	1386	Taper Roller	WSU-6TM
8"	2"	20 mm	2-3/8"	2090	Roller	WSU-8RBM20
8"	2"	25 mm	2-3/8"	2090	Roller	WSU-8RBM25
8"	2"	1"	2-3/8"	2090	Roller	WSU-8LRB
8"	2"	12 mm	2-3/8"	2090	Ball Journal	WSU-8BJM12
8"	2"	20 mm	2-1/4"	2090	Ball Journal	WSU-8BJM20
8"	2"	25 mm	2-1/4"	2090	Ball Journal	WSU-8BJM25
8"	2"	1/2"	2-3/8"	2090	Taper Roller	WSU-8TM
8"	3"	25 mm	3-5/8"	2400	Ball Journal	WSU-83BJM25
8"	3"	1/2"	4-1/8"	2400	Taper Roller	WSU-8TM
8"	3"	3/4"	3-5/8"	2400	Taper Roller	WSU-108TM
10"	2"	25 mm	2-3/8"	2290	Roller	WSU-10RBM25
10"	2"	1"	2-3/8"	2290	Roller	WSU-10RB
10"	2"	1-1/4"	2-3/8"	2290	Roller	WSU-10LRB
10"	2"	12 mm	2-3/8"	2290	Ball Journal	WSU-10BJM12
10"	2"	25 mm	2-1/4"	2290	Ball Journal	WSU-10BJM25
10"	2"	1/2"	2-3/8"	2290	Taper Roller	WSU-10TM
10"	3"	1/2"	4-1/8"	3500	Taper Roller	WSU-103TM
10"	3"	3/4"	3-5/8"	3500	Taper Roller	WSU-110TM
10"	3"	1-1/4"	3-5/8"	5000	Taper Roller	WSU-210TM
10"	3"	1-1/2"	3-3/4"	5000	Roller	WSU-210RB
12"	2-1/4"	25 mm	2-3/8"	2400	Roller	WSU-12RBM25
12"	2-1/4"	1"	2-3/8"	2400	Roller	WSU-12RB
12"	2-1/4"	1-1/4"	2-3/8"	2400	Roller	WSU-12LRB
12"	2-1/4"	12 mm	2-3/8"	2400	Ball Journal	WSU-12BJM12
12"	2-1/4"	25 mm	2-1/4"	2400	Ball Journal	WSU-12BJM25
12"	2-1/4"	1/2"	2-3/8"	2400	Taper Roller	WSU-12TM
12"	3"	1-1/4"	3-5/8"	5000	Taper Roller	WSU-212TM
12"	3"	1-1/2"	3-3/4"	5000	Roller	WSU-212RB
12"	4"	1-1/4"	4-5/8"	6490	Taper Roller	WSU-312TM
16"	5"	1-3/8"	5-5/8"	9966	Taper Roller	WSU-516TM

\* Revvo supplies bushings to adapt metric shaft diameters to Imperial/inches.



WSU Series Polyurethane-on-Cast-Iron Wheels



WSU Series with Taper Roller Bearing (6" to 12")

Superthane wheels combine the load capacity and wear resistance of cast iron with the rolling advantages of a soft, resilient tread (e.g. low tractive resistance). Tear strength is two-to-five times greater than that of natural rubber, and the high abrasion resistance provides a service life ten times greater than a rubber tire. Resilient tread. Red finish.

## WRP SERIES RUBBER-ON-PLASTIC WHEELS

The Flexello WRP Series gray rubber tire/plastic center, light-duty wheels are available in sizes ranging from 1-5/8" to 4" with load capacities from 30 to 77 lbs. Resilient tread. Gray finish.

### WRP SERIES

Wheel Diameter	Tread Width	Shaft Diameter	Hub Length	Load Capacity	Bearing+	Wheel Part #
1-5/8"	3/4"	1/4"	7/8"	30	Plain	WRP-158
2"	3/4"	1/4"	7/8"	40	Plain	WRP-234
2-1/2"	7/8"	1/4"	1"	51	Plain	WRP-2578
3"	7/8"	5/16"	1"	66	Plain	WRP-378
4"	7/8"	5/16"	1"	77	Plain	WRP-478

+ Contact factory for precision bearing wheel selection.



WRP Series Rubber-on-Plastic Wheels

## WPN SERIES POLYNYL-INJECTION WHEELS

The Revvo WPN Series "Polynyl-Injection" red polyurethane tire/nylon center wheels are available in sizes from 4" to 8" with load capacities from 264 to 1,190 lbs. Gray finish.

### WPN SERIES

Wheel Diameter	Tread Width	Shaft Diameter*	Hub Length	Load Capacity	Bearing	Wheel Part #
4"	1-3/8"	12mm	1-9/16"	264	Roller	WPN-41RMB12
4"	1-3/8"	15mm	1-7/8"	440	Plain	WPN-4M15
4"	1-3/8"	15mm	1-7/8"	440	Roller	WPN-4RBM15
5"	1-3/8"	12mm	1-7/8"	330	Roller	WPN-51RBM12
5"	1-3/8"	15mm	1-9/16"	550	Plain	WPN-5M15
5"	1-3/8"	15mm	1-9/16"	650	Roller	WPN-5RBM15
6"	1-3/4"	20mm	2-3/8"	880	Plain	WPN-6M20
6"	1-3/4"	20mm	2-3/8"	880	Roller	WPN-6RBM20
8"	2-1/8"	20mm	2-3/8"	1190	Plain	WPN-8M20
8"	2-1/8"	20mm	2-3/8"	1190	Roller	WPN-8RBM20
8"	2-1/8"	12mm	2-3/8"	1190	Ball Journal	WPN-8BJM12
8"	2-1/8"	20mm	2-1/4"	1190	Ball Journal	WPN-8BJM20
8"	2-1/8"	25mm	2-1/4"	1190	Ball Journal	WPN-8BJM25

\* Revvo supplies bushings to adapt metric shaft diameters to Imperial/inches.



WPN Series Polyurethane-on-Nylon Wheels

## WPSW SERIES RUBBER-ON-PLASTIC WHEELS

The Flexello WPSW Series gray rubber tire/plastic center wheels are available in sizes of 4" and 5" with load capacities from 132 to 176 lbs. Resilient tread. Gray finish. (Contact factory for black finish.)

### WPSW SERIES

Wheel Diameter	Tread Width	Shaft Diameter*	Hub Length	Load Capacity	Bearing	Wheel Part #
4"	1-3/8"	12mm	1-9/16"	132	Plain	WPS41WM12
4"	1-3/8"	12mm	1-9/16"	132	Roller	WPS41RBWM12
5"	1-3/8"	12mm	1-9/16"	176	Plain	WPS51WM12
5"	1-3/8"	12mm	1-9/16"	176	Roller	WPS51RBW12

\* Revvo supplies bushings to adapt metric shaft diameters to Imperial/inches.



WPSW Series Rubber-on-Plastic Wheels



**Flexell** 



**Available from:**



The Revvo Caster Company, Inc.  
2420 North America Drive  
West Seneca, NY 14224

In Canada:  
P.O. Box 236  
Fort Erie, ON L2A 5M9

Phone: 716-675-9609  
Fax: 716-677-2363  
TOLL-FREE: 1-888-883-3596  
[www.RevvoCaster.com](http://www.RevvoCaster.com)

*A Colson Associates Company*

Distributed by:

